



FLAT DISPLAY TECHNOLOGY



This product is RoHS compliant

§ SPECIFICATION APPROVAL SHEET §

Fdt Tech Module No: **LOF104Y1DP-00R**

Description: **10.4" Digital TFT-LCD Module**

SPEC No.: **SAS-2404002**

Version: **0.1**

Issue Date: **June 24, 2025**

※ This approval sheet contains 24 pages including the cover and appendix.

Customer:	Approved By:
Date: / / 25	

Approved By: _____ Checked By: _____ Designed By: _____



1. General Description

1.1 Features

- Full Flat Panel Design
- 10.4" (1024x768) Digital TFT LCD
- Aspect Ratio: 4:3
- Input Signal VGA / DVI-D / HDMI 1.3a
- Maximum Support Resolution 1920x1080
- Stereo Audio Amplifier, Output 2W@4Ω Speaker
- Audio Line-In
- 2 Points Projected Capacitive Touch
- 5 Key Buttons Control
- 9 Language OSD Menu
- LED Backlight
- Wide Operation Voltage +11V ~ +28V

1.2 Applications

- Industrial
- Medical Environment
- Instrument Display
- Kiosk
- Security
- Signage
- Office Electronics
- Home Application
- Educate Application



2. Contents

Contents	Page
1. General Description.....	1
1.1 Features	1
1.2 Applications	1
2. Contents.....	2-3
3. Specifications.....	4
4. Block Diagram.....	4
5. Order Information.....	5
5.1 Unit	5
6. Accessories (Option).....	6
7. Pin Description.....	7-10
7.1 DC-In : Pin Assignment of Power Input (DC-Jack Inside Diameter:2.1 ϕ Outside Diameter:5.5 ϕ Side Entry Type)	7
7.2 VGA : Pin Assignment of Analog RGB Input (D-Sub 15Pin)	7
7.3 DVI : Pin Assignment of DVI-D (24 Pin)	8
7.4 HDMI : Pin Assignment of HDMI-A Type Input (HDMI 1.3a -19Pin Female)	9
7.5 L : Pin Assignment of Speaker Left (Pitch 2.0mm 2Pin , Side Entry Type)	9
7.6 R : Pin Assignment of Speaker Right (Pitch 2.0mm 2Pin , Side Entry Type)	10
7.7 USB Port : Pin Assignment of Touch USB (USB A Type - Female 2.0mm, Side Entry Type)	10
7.8 Line-In : Pin Assignment of Line-In/Ear Phone (Option) (Outside Diameter:3.5 ϕ Side Entry Type)	10
8. Absolute Maximum Ratings.....	11
8.1 Absolute Maximum Ratings	11
9. Recommended Operating Conditions.....	11
9.1 Electrical Characteristics	11
9.2 Support Display Mode Characteristics	11
10. Projected Capacitive Touch Panel Characteristics.....	12-13
10.1 Electrical Performance	12
10.2 Optical Performance	12
10.3 Mechanical Performance	12
10.4 Touch Panel Operation System Support	13
11. Installing the Monitor.....	14-15
11.1 Power cable connection	14
11.2 VGA signal cable connection	14
11.3 Switch on the power	14
11.4 Panel Mount Installation (Mount Clamp and Screw)	15
12. Key Function by OSD.....	16-20
12.1 Menu Operation	16-20
13. Dimension Information	21



13.1 Unit (LOF104Y1DP-00R)	21
14. Appendix	22
14.1 TFT-LCD Mechanical Specifications	22
14.2 TFT-LCD Optical Characteristics	22
15. Revision History	23
15.1 Record of Revision	23

Preliminary



3. Specifications

LCD	
Panel Size	10.4"
Resolution (Pixels)	1024x768
Color	16.2M
Luminance without TP	600 cd/m ²
Luminance (PCAP)	522 cd/m ²
Contrast Ratio	900
View Angle	85(L) / 85(R) / 85(T) / 85(B)
LED Life Time (Min.)	30K hours
Power Requirement	
Power Input (DC Jack 2.1 φ)	+11V ~ +28Vdc
Power Consumption@+12V	8.04 Watts (@Without Amplifier)
Touch Screen	
PCAP Type	USB Interface (2 Points)
Projected Capacitive Touch Support OS	Windows / Linux

Input Signal		
VGA	D-Sub15	
DVI	DVI-D	
HDMI	1.3a	
Audio		
Amplifier	1W@8Ω / 2W@4Ω	
Line-In	Stereo Input Phone Jack φ 3.5	
Controls		
Key	5 Buttons	
Serial Remote Control	RS232 (Option)	
Mechanical		
Construction	Aluminum Front Bezel with Completely Covered Glass and SECC steel chassis	
Mounting Type	Panel / VESA 100 x 100 Mount	
Environment		
Temperature Range	Operating	-20~+70°C
	Storage	-20~+70°C
High Temperature & High Humidity (Non-condensing)	Operating	+60°C / 90%

4. Block Diagram

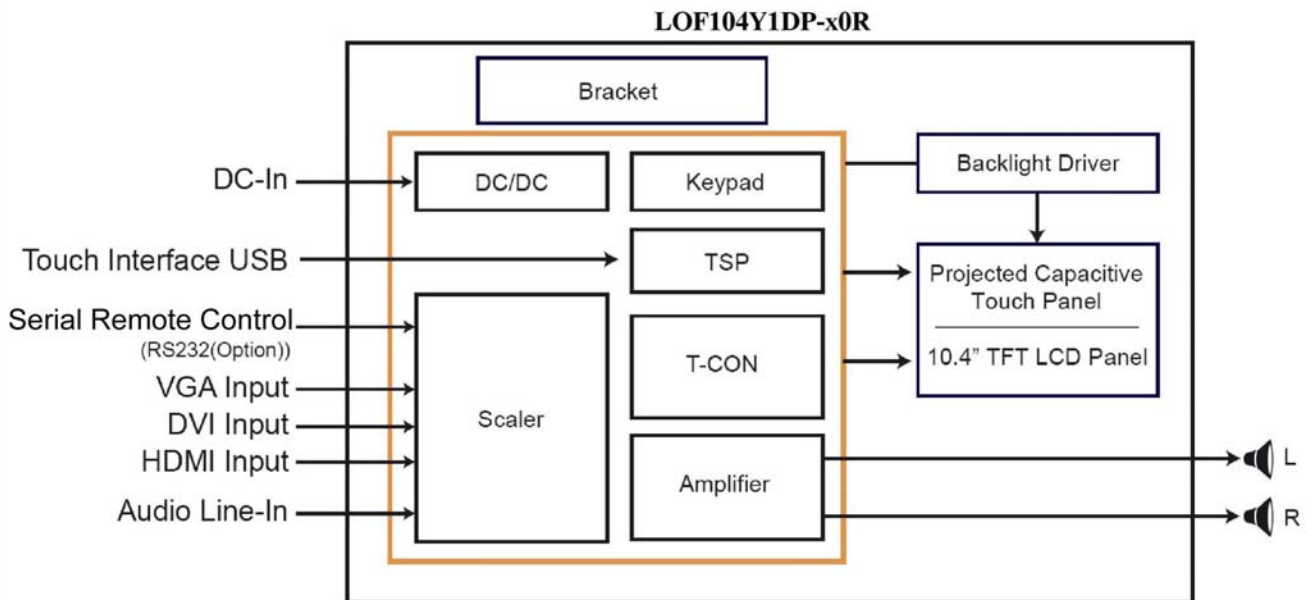



5. Order Information

5.1 Unit

Item	LOF104Y1DP-00R	Unit	Remark
VGA	⊙		
DVI	⊙		
HDMI	⊙		
Touch Panel Type	Projected Capacitive Touch		
Touch Screen Interface	USB		
Audio Amplifier	⊙		
Audio Line-In	⊙		
5 Keys	⊙		
Waterproof	-		
Dimension	265.8 x 213 x 45.7	mm	
Weight	1.7	Kg	±10%
Condition	Standard		

Note: 1.The assembling of panel and bracket is aimed for delivery, packaging and experiment. If the demand of shockproof and long-term fix, pls have it into consideration of mechanism design.

5.2 Customized

Function	Item	Remark
Audio	Head Phone For HDMI (Output)	
Serial Remote Control	RS232 (DB9)	
Power Input Connector	Terminal Socket 2P 5.08mm (on Module)	
	Terminal plug 2P 5.08mm (For Cable)	 Matching Terminal Socket

Note: Special order condition will apply to non-standard items and pls contact salespersons in FDT.

6. Accessories (Option)

Before you begin installing the Open Frame, please make sure that the following materials have been shipped:



A. LASTD12033-FDR



B. LAACD18000-FDR



C. LACABLE068-FDR



D. LACABLE069-FDR



E. LAVGA18000-FDR



F. LAUSB18000-FDR



G. LACABLE070-FDR



H. LASPKR0004-FDR



I. LASCW00003-FDR

- A. AC to DC Adapter (L:1500mm, 100-240V_{AC} 50-60Hz to +12V_{DC} @ 3.3A, ϕ 2.1)
- B. Power Cord (L:1800mm, Plug Type B for USA)
- C. HDMI Cable (L:1800mm)
- D. DVI Cable (L:1800mm)
- E. VGA Cable (L:1800mm)
- F. USB Cable (L:1800mm)
- G. AUDIO Cable (L:1800mm)
- H. Speaker (2.5W @ 4 Ω L:400mm *2 Pieces)
- I. Mount Clamp and Screw *12 Pieces



7. Pin Description

7.1 DC-In : Pin Assignment of Power Input (DC Jack Inside Diameter:2.1 φ Outside Diameter:5.5 φ Side Entry Type)

Pin No.	Symbol	I/O	Description	Remark
1	DC-In	P	+11~+28 Vdc Input Voltage	
2	GND	P	Power Ground	

I: input, O: output, P: Power/GND



Positive Polarity

7.2 VGA : Pin Assignment of Analog RGB Input (D-Sub 15Pin)

Pin No.	Symbol	I/O	Description	Remark
1	RI+	I	Analog Red Signal	
2	GI+	I	Analog Green Signal	
3	BI+	I	Analog Blue Signal	
4	GND	P	Ground	
5	VGA-Det	-	VGA Detect	
6	AGND	P	Analog Ground	
7	AGND	P	Analog Ground	
8	AGND	P	Analog Ground	
9	VGA5V	P	VGA +5Vdc Input	
10	GND	P	Ground	
11	GND	P	Ground	
12	VGA_SDA	I/O	DDC2 Data	
13	HS_IN	I	TTL Horizontal sync.	
14	VS_IN	I	TTL Vertical sync.	
15	VGA_SCL	I	DDC2 Clock	

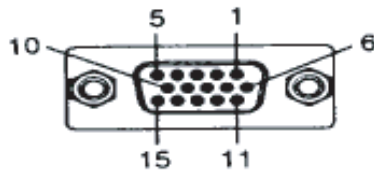

7.3 DVI : Pin Assignment of DVI-D (24 Pin)

Pin No.	Symbol	I/O	Description	Remark
1	DATA2-	I	Negative DVI Input for A Link Data Channel 2	
2	DATA2+	I	Positive DVI Input for A Link Data Channel 2	
3	GND	P	Ground	
4	NC	-	No Connection	
5	NC	-	No Connection	
6	DVI_SCL	I	DDC2 Clock	
7	DVI_SDA	I/O	DDC2 Data	
8	NC	-	No Connection	
9	DATA1-	I	Negative DVI Input for A Link Data Channel 1	
10	DATA1+	I	Positive DVI Input for A Link Data Channel 1	
11	GND	P	Ground	
12	NC	-	No Connection	
13	NC	-	No Connection	
14	DVI5V	P	DVI +5Vdc Input	
15	DET_DVI	-	DVI Detect	
16	DVI_HPD	O	Hot Plug Detect	
17	DATA0-	I	Negative DVI Input for A Link Data Channel 0	
18	DATA0+	I	Positive DVI Input for A Link Data Channel 0	
19	GND	P	Ground	
20	NC	-	No Connection	
21	NC	-	No Connection	
22	GND	P	Ground	
23	DCLK+	I	Positive DVI Input for A Link Clock Channel	
24	DCLK-	I	Negative DVI Input for A Link Clock Channel	

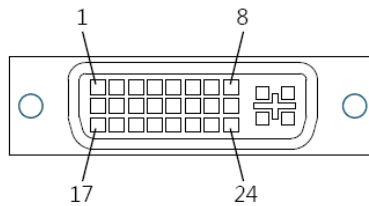

7.4 HDMI : Pin Assignment of HDMI-A Type Input (HDMI 1.3a -19Pin Female)

Pin No.	Symbol	I/O	Description	Remark
1	DATA2+	I	Positive HDMI Input for B Link Data Channel 2	
2	DET_HDMI	-	HDMI Detect	
3	DATA2-	I	Negative HDMI Input for B Link Data Channel 2	
4	DATA1+	I	Positive HDMI Input for B Link Data Channel 1	
5	GND	P	Ground	
6	DATA1-	I	Negative HDMI Input for B Link Data Channel 1	
7	DATA0+	I	Positive HDMI Input for B Link Data Channel 0	
8	GND	P	Ground	
9	DATA0-	I	Negative HDMI Input for B Link Data Channel 0	
10	DCLK+	I	Positive HDMI Input for B Link Clock Channel	
11	GND	P	Ground	
12	DCLK-	I	Negative HDMI Input for B Link Clock Channel	
13	NC	-	No Connection	
14	NC	-	No Connection	
15	HDMI_SCL	I	DDC2 Clock	
16	HDMI_SDA	I/O	DDC2 Data	
17	GND	P	DDC/CEC Ground	
18	HDMI5V	P	HDMI +5Vdc Input	
19	HDMI_HPD	O	Hot Plug Detect	

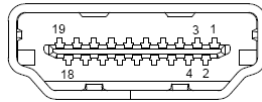

7.5 L : Pin Assignment of Speaker Left (Pitch 2.0mm 2Pin , Side Entry Type)

※ FDT Connector Part No.: A2001WR2-2P(JWT) ;

※ FDT Matching Connector Part No.: A2001H02-2P(JWT) .

Pin No.	Symbol	I/O	Description	Remark
1	+LOUT	O	Left Speaker Out+	
2	-LOUT	O	Left Speaker Out -	

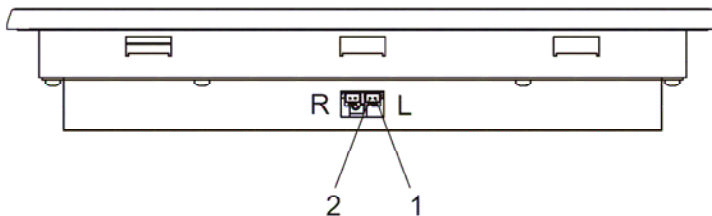

7.6 R : Pin Assignment of Speaker Right (Pitch 2.0mm 2Pin , Side Entry Type)

※ FDT Connector Part No.: A2001WR2-2P(JWT) ;

※ FDT Matching Connector Part No.: A2001H02-2P(JWT) .

Pin No.	Symbol	I/O	Description	Remark
1	+ROUT	O	Right Speaker Out+	
2	-ROUT	O	Right Speaker Out-	

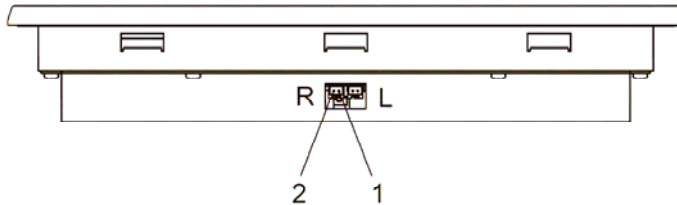

7.7 USB Port : Pin Assignment of Touch USB (USB A Type - Female 2.0mm, Side Entry Type)

Pin No.	Symbol	I/O	Description	Remark
1	VBUS	P	USB VCC	
2	D-	-	DATA (-)	
3	D+	-	DATA (+)	
4	DGND	P	Digital Ground	

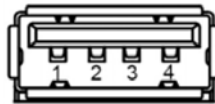

7.8 Line-In : Pin Assignment of Line-In/Ear Phone (Option) (Outside Diameter:3.5 φSide Entry Type)

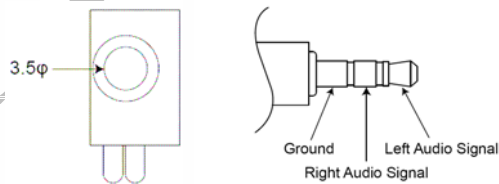



8. Absolute Maximum Ratings

8.1 Absolute Maximum Ratings

Parameter	Symbol	Min	Max	Unit	Remark
Input Voltage	Vin	10.5	28.5	V	
Analog RGB Input Signal	Analog RGB in	0.5	2.0	Vp-p	
Digital Input Signal	TTL	0.3	3.6	V	
DVI Input Signal		-	165	MHz	
HDMI Input Signal		-	165	MHz	
Line-in			1.8	Vp-p	
Operating Temp.		-20	+70	°C	
Storage Temp.		-20	+70	°C	
High Temperature & High Humidity (Non-condensing)		-	+60°C / 90%	°C / %	

9. Recommended Operating Conditions

9.1 Electrical Characteristics

Parameter	Symbol	I/O	Min	Typ	Max	Unit	Note
Input Voltage	DC-in	I	11	12	28	V	
Without Amplifier	Total Current	I-in	I	670	-	mA	@+12V
	Power Consumption		I	8.04	-	W	±15% Note
With Amplifier	Total Current	I-in	-	1170	-	mA	@+12V load :4Ω Play: sine wave 1khz. Line-In input: 1.78Vpp Volume=63
	Power Consumption		I	14.04	-	W	±15% Note
Output Voltage	VDD	O	3.2	3.3	3.4	V	
Analog RGB Input Signal	Analog RGB in	RGB I	-	0.7	-	Vp-p	@75Ω
DVI Input Signal			-	-	165	MHz	
HDMI Input Signal			-	-	165	MHz	

Note: Test Condition

1. VGA: Resolution 1024x768 @ input = PC desktop screen @ Brightness(default)=48



9.2 Support Display Mode Characteristics

Dots per inch	Standard	H	Unit	Polarity	V	Unit	Polarity	Note
640 × 480	VGA	31.5	KHz	Negative	59.9	Hz	Negative	
800 × 600	VESA	37.9	KHz	Positive	60.3	Hz	Positive	
1024 × 768	VESA	48.4	KHz	Negative	60	Hz	Negative	
1280 × 1024	VESA	64	KHz	Positive	60	Hz	Positive	
1600 × 1200	VESA	75	KHz	Positive	60	Hz	Positive	
1920 × 1080	VESA	67.5	KHz	Positive	60	Hz	Positive	

Note: Polarity & standard only for VGA mode

10. Projected Capacitive Touch Panel Characteristics

10.1 Electrical Performance

Parameter	Symbol	Min	Typ	Max	Unit	Note
Input Voltage		-	-	5V		
Response Time		25		30	ms	

10.2 Optical Performance

Parameter	Specifications
Light Transmittance	≥87%

10.3 Mechanical Performance

Parameter	Specifications
Input Method	Stylus for PCAP or Finger Available
Touch Function	2 Points
Interface	USB
Surface Hardness	≥6H
Cover Spec.	Chemically strengthened T=1.8mm Black Printing
Knock Test	10,000,000 times above



10.4 Touch Panel Operation System Support

Driver Vender : EETI (eGalax_eMPIA Technology Inc.)

OS	Version	Interface
Windows	Windows 7, 8, 8.1, 10, 11	USB
	Windows Embedded 7, 8	
	Windows Embedded POSReady 2009 POSReady 7	
	Embedded Standard 7	
	Embedded Enterprise 7	
	Embedded 8 Standard	
	Embedded 8.1 Pro/ Embedded 8.1 Industry	
	Windows , XP, 2000	
Windows CE	Windows XP Embedded	USB
	Windows Embedded Compact 2013,7	
	Windows CE 6.0	
Linux	Windows CE.Net (4.x / 5.0)	USB
	Kernel 2.6.24 Upward and 3.x.x / 4.x.x / 5.x.x (X86 / ARM / MIPS)	
	Kernel 2.6.23 Downward (X86)	
Android	Kernel 2.4.x (x86)	USB
	Android Version 2.3.x upwards (X86 / ARM / MIPS)	
Mac OS	Mac OS X 10.5.3 Leopard (Power PC)	USB
	Mac OS X 10.7.4 Earlier (32Bit /64Bit)(Intel CPU)	
	Mac OS X 10.7.5 (32Bit) (Intel CPU)	
	Mac OS X 10.7.5 (64bit) (Intel CPU)	
	Mac OS X 10.8.x Mountain Lion (Intel CPU)	
	Mac OS X 10.9.x Mavericks (Intel CPU)	
	Mac OS X 10.10.x Yosemite (Intel CPU)	
	Mac OS X 10.11 El Capitan (Intel CPU)	
	Mac OS 10.12 Sierra (Intel CPU)	
	Mac OS 10.13 High Sierra (Intel CPU)	
	Mac OS 10.14 Mojave (Intel CPU)	
	Mac OS 10.15 Catalina (Intel CPU)	
	QNX	
QNX Neutrino RTOS V6.3		

Note: 1. Please refer to the FDT website for the driver installation and support operating system.

FDT website: <http://www.fdt.com.tw>

2. Please refer to the FDT website for the latest driver version and support operating system.
3. After installing the driver, the default navigation mode will be set as Mouse in OS.
4. Please contact Sales for Projected Capacitive. The driver is a mouse emulation driver. If your USB interface touch device is projected capacitive type and Windows version is Windows 7 or later, we suggest you do not install this driver. There is a HID touch digitizer build-in driver in Windows 7 or later. If your need RS-232 interface driver for projected capacitive type touch device , please contact us.

11. Installing the Monitor

11.1 Power cable connection:

Connect the power cord to the AC outlet, and connect the power to the monitor through the AC/DC adapter.

11.2 VGA signal cable connection:

Plug one end of the 15-pin signal cable to the VGA connector at the rear of the PC system and the other end to the Open Frame monitor.

Secure the connectors with the screws on the cable connector at both ends.

11.3 Switch on the power:

Switch on the power switch on the rear cover of the Open Frame Monitor.

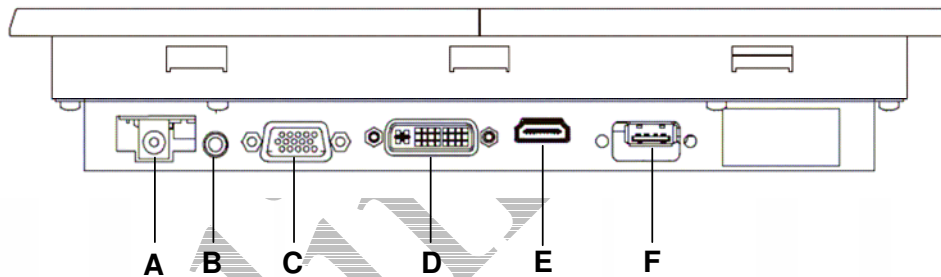

- A. DC-In (+12V_{DC} The DC jack core is positive)
- B. Line-In : Phone Jack ϕ 3.5
- C. VGA D-sub 15 (Female)
- D. DVI
- E. HDMI
- F. USB (For Touch Controller)

11.4 Panel Mount Installation (Mount Clamp and Screw):

Recommended opening dimension for monitor installation.

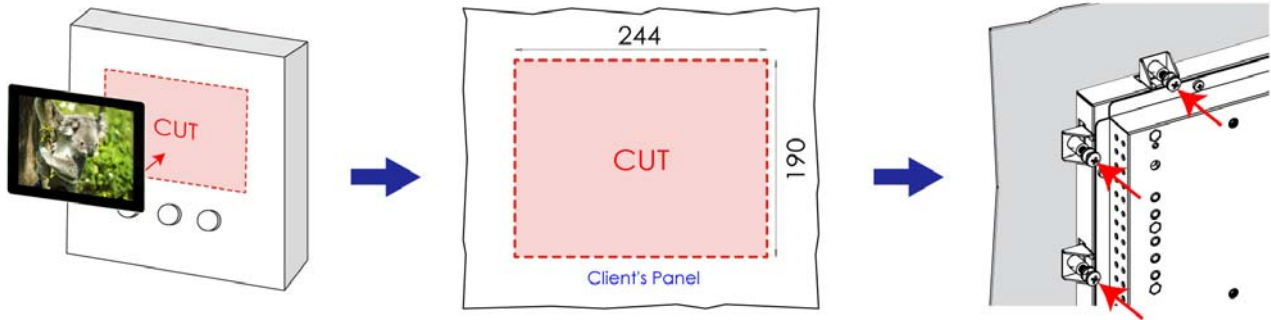



12. Key Function by OSD

12.1 Menu Operation

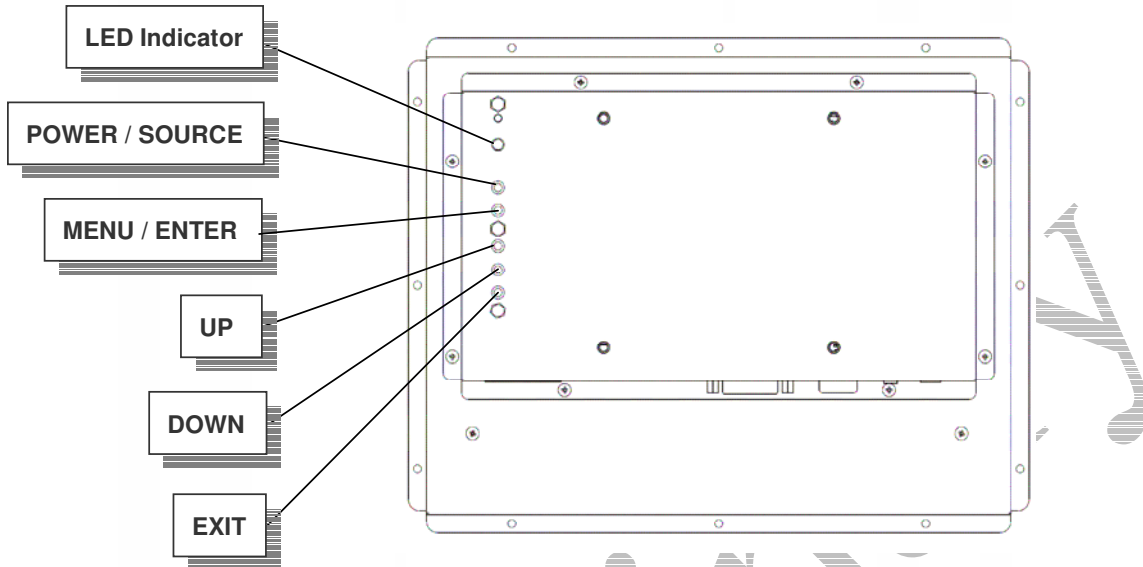

OSD ICON Instructions :

1. POWER : Power On/Off (※Press for 3 secs to turn off)
2. MENU / ENTER : (After turning on MENU, only ENTER is available)
3. UP : Move Upward / Increase Value / Option Switch
4. DOWN : Move Downward / Decrease Value / Option Switch
5. EXIT : Return to Previous Page
6. LED Indicator
 - Waiting : Flickering Green
 - Power ON : Green
 - Power OFF : Red

Save OSD Setting:

1. EXIT MENU and settings will be saved automatically
2. Settings will be saved as well when MENU shuts down automatically

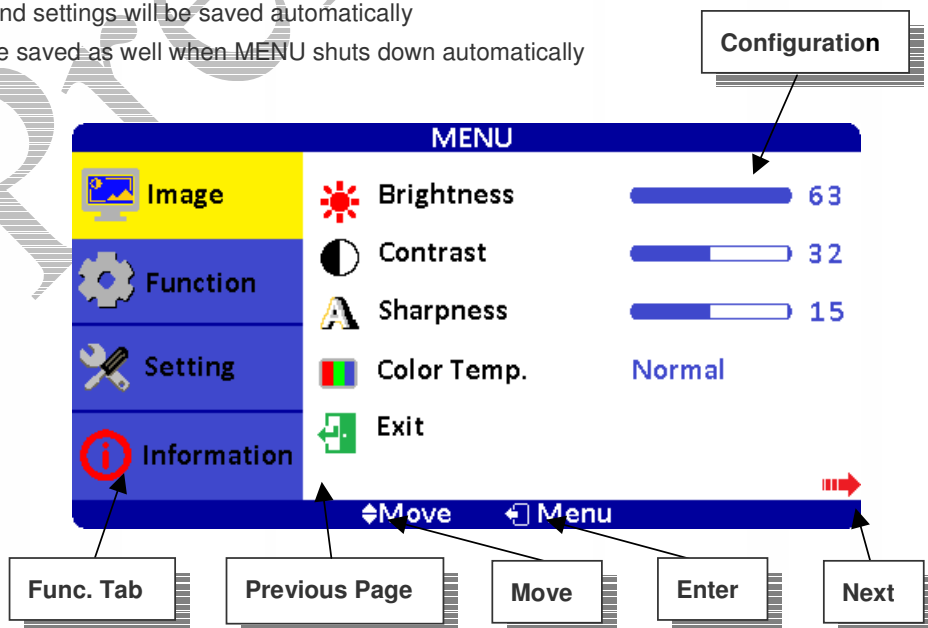

Note: This is a schematic diagram of the OSD menu. Please refer to the actual module for the correct setting value.



Overview of the Menu :



Image

Indicator	Meaning	Default	Adjustable range	Remark
	Brightness	48	0~63	Adjust-Bar
	Contrast	46	0~63	Adjust-Bar
	Sharpness	10	1~31	Adjust-Bar
	Color Temp.	Normal	Normal / Warm / Cool / sRGB / *User Define	Note3
	H-Position	-	-50~+50	Note1
	V-Position	-	-50~+50	Note1
	Clock	-	-50~+50	Note2
	Phase	-	0~127	Note1
	Auto	By different resolution		VGA only
	Exit			

Note1 Values will be different through signal source

Note2 Values will be different after Auto and Reset

Note3: Explain User Define

Indicator	Meaning	Default	Remark
	Red	128	
	Green	128	
	Blue	128	



Function

ICON	Meaning	Function	Default	Status	Description	Remark
	Show Status	Information of input source	On	On	Show input source	
				Off	Hide input source	Note2
	Blue Screen	Select blue/ black screen when no input signal is detected.	On	On	Show blue screen when no input.	
				Off	Show black screen when no input.	
	Auto Power On	Modules turns on automatically without power key input.	On	On	Auto	
				Off	Manual	
				Auto Save	Power off , the last state	



	Detect Source	Auto detect input source.	On	On	Auto-detect signal source	
				Off	Manual switch signal source	
	Auto Power Saving	Modules go standby when no input source is detected.	Off	0s / 6s / 15s / 30s	Go standby by settings when no input	LED indicator: Flickering Green
				Off	Show no signal when no input	LED indicator: Green
	Auto Sleep	Modules go off when set timing is out.	Off	15m / 30m / 60m / 120m	Go off by time setting	LED indicator: Red Press Power Key back to life.
				Off	Turn off sleep mode	
	Exit					

Note : After configuration is set, RESET won't restore to default setting.

Note2 : Explain Hide input source

Indicator	Meaning	Default	Remark
	Show Please Wait	Off	
	Show Countdown	Off	



Setting

Indicator	Meaning	Default	Adjustable range	Remark
	Volume	32	0~63	
	Mute	Off	On / Off	On : Mute · Off : Sound
	Aspect Ratio	Full	Full / 4:3	
	Language	English	English / 中文 / 日本語 / 한국의 / Française / Deutsch / Italiano / Española / Português	Reset won't restore to default setting
	OSD Transparent	1	0~15	
	Reset			Restore to default
	Exit			



Info.

MENU	
Image	Source : HDMI
Function	Resolution : 1024x768
Setting	H.Freq : 48.2KHz + V.Freq : 59.8Hz -
Information	Program Ver : 4.00 Command Ver : 4.00
↔ Move ← Menu	

Note : Above is only for reference, the correct content should be based on actual goods.

Hot Key When OSD Menu is Off :

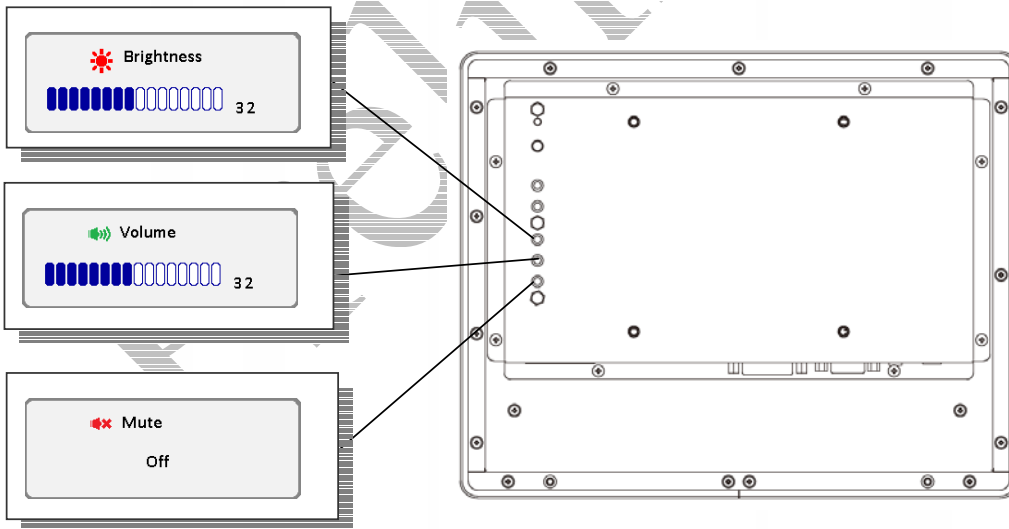

Information of Input Source and Functionality :

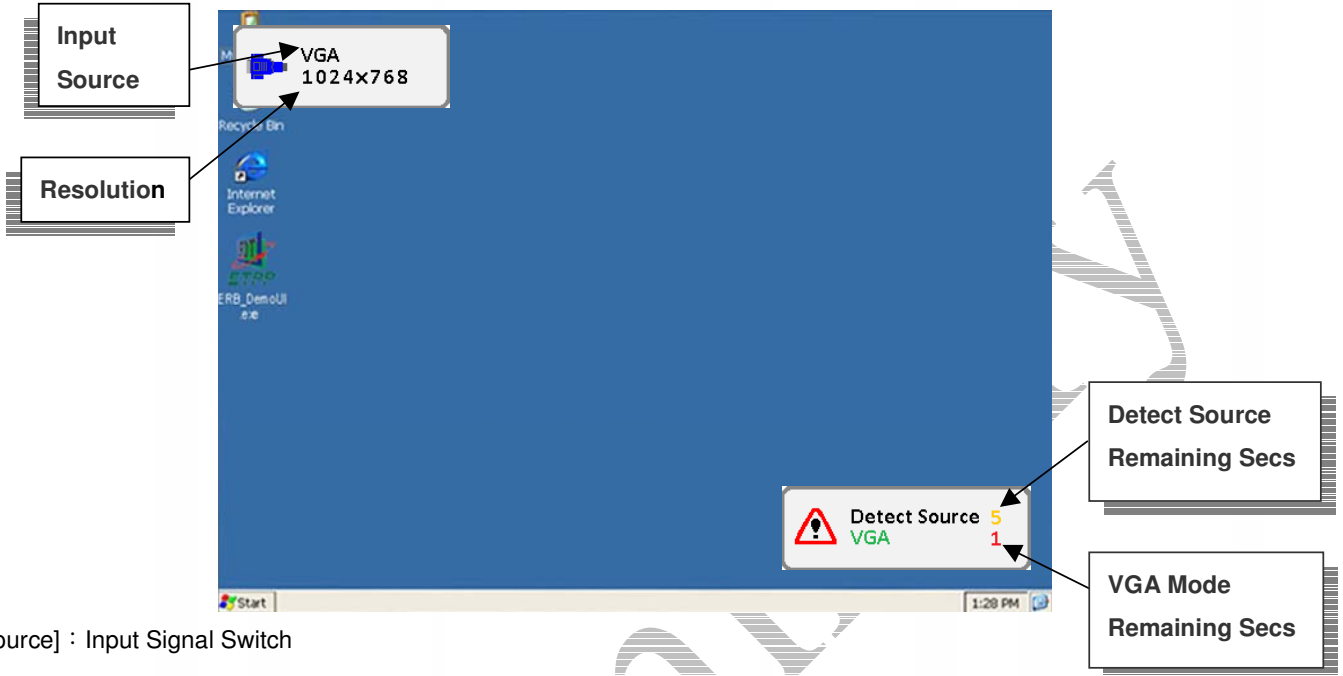

[Source] : Input Signal Switch

Overview of Input Signals :

Indicator	Interface
	VGA
	DVI
	HDMI



13. Dimension Information

13.1 Unit (LOF104Y1DP-00R)

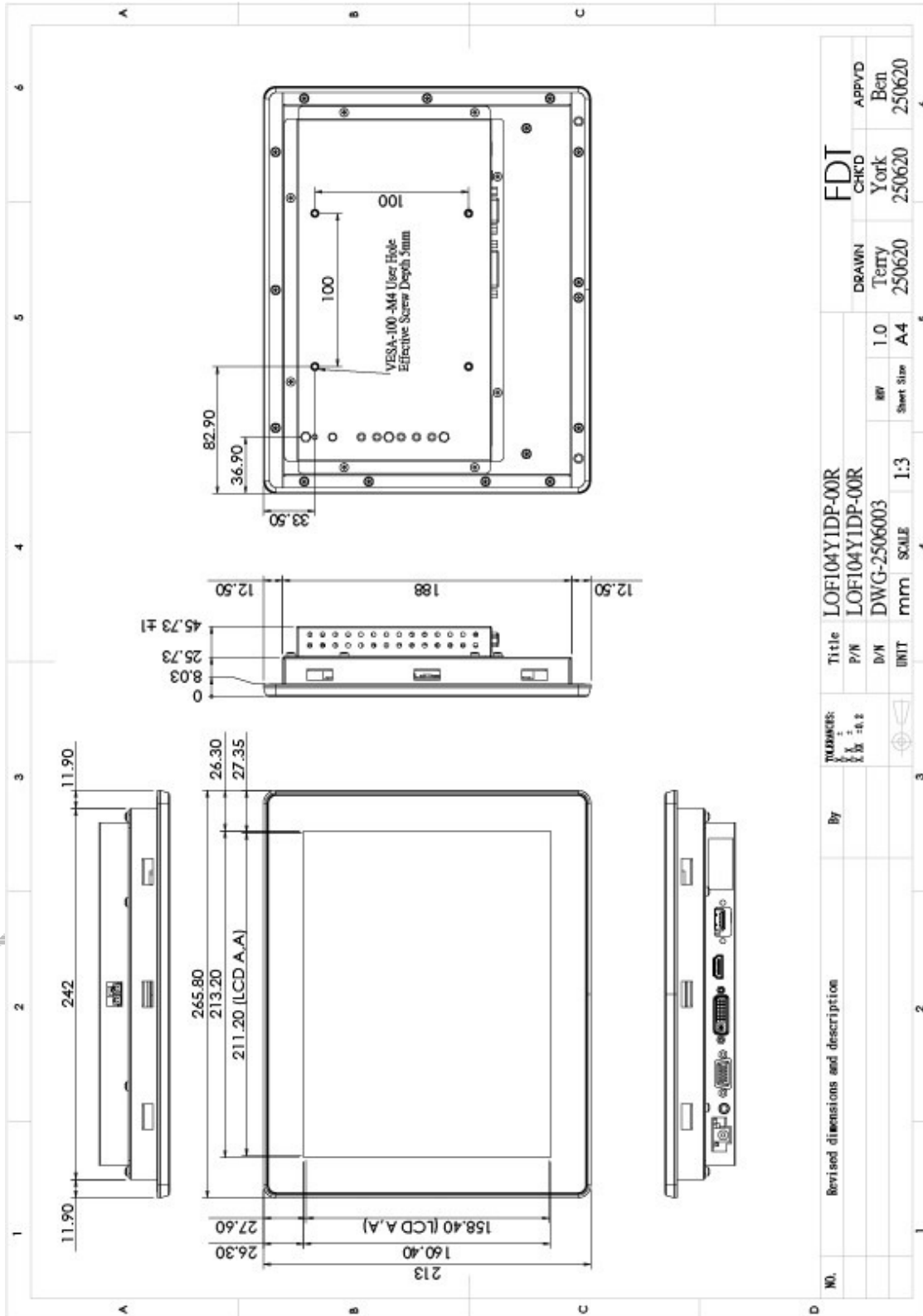



14. Appendix

14.1 TFT-LCD Mechanical Specifications

Parameter	Specifications	Unit
Screen Size	10.4 (diagonal)	Inch
Display Format	1024 x (R.G.B) x 768	Dot
Active Area	211.2(H) x 158.4(V)	mm
Pixel Pitch	0.20625(H) x 0.20625(V)	mm
Pixel Arrangement	RGB vertical stripe	
Surface Treatment	Anti-Glare, Hard Coating (3H)	

14.2 TFT-LCD Optical Characteristics

Parameter	Symbol	Condition	Min	Typ	Max	Unit	Remark
Viewing Angle	Horizontal	Left	80	85	---	deg	
		Right	80	85	---	deg	
	Vertical	Top	80	85	---	deg	
		Bottom	80	85	---	deg	
Contrast Ratio	CR	At optimized Viewing angle	600	900	---	---	
Luminance without PCAP	L		500	600	---	cd/ m ²	
LED Life Time		25°C	30000	---	---	hours	Note

Note: The "LED Life Time" is defined as the module brightness decrease to 50% original.

